

Specifications

备注(Remark)

1.材料(MATERIAL)

胶芯:PA6T/PBT+30%G.F UL94V-0,颜色:黑色.

Housing: PA6T/PBT+30%G.F UL94V-0,Color: Black 黄铜,

四方针:镍底30u"MIN,表面镀金0.8u"MIN

Contact: Brass,0.8u"MIN GOLD PLATING OVERALL

30u" MIN NICKEL UNDERPLATING OVER ALL

2.特性(characteristics):

额定电流: 3AMP

Raring Current: 3AMP.

接触阻抗: 20 MΩ MAX.

Contact Resistance: 20 MΩ MAX.

绝缘阻抗: 1000 MΩ MIN.

Insulating Resistance: 1000 MΩ MIN.

耐电压: AC 500V.

Withstanding Voltage:AC 500V.

温度范围:-40°C to+105°C

Temperature Range:-40°C to+105°C

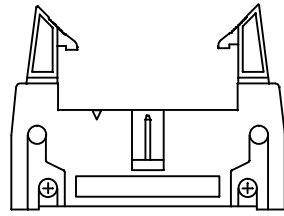

注:10P-18P产品缺口两侧为平面

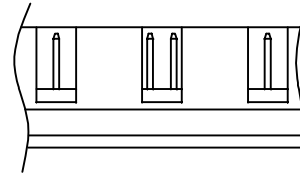

注:60P-64P产品有中间有三个缺口,其余PIN中间为一个缺口

2.54三件式IDC

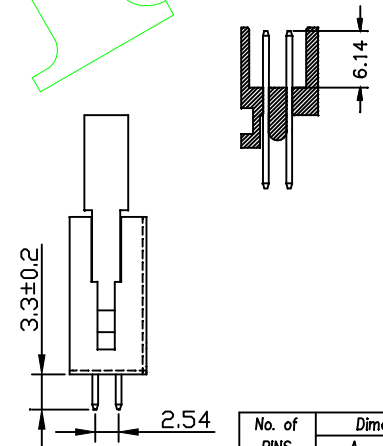
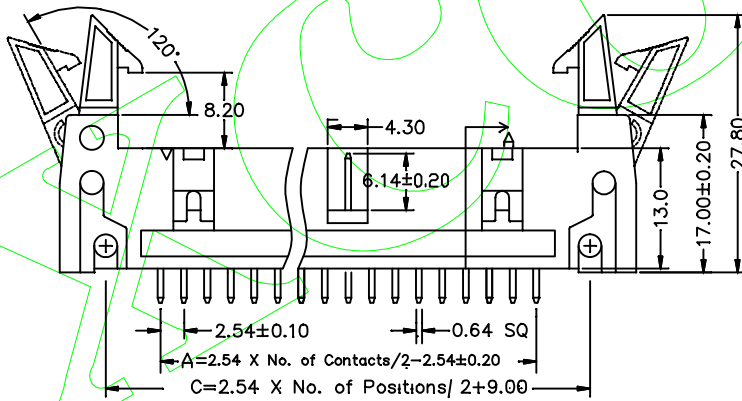
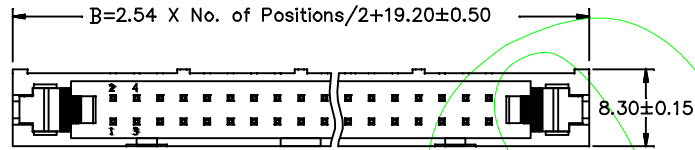
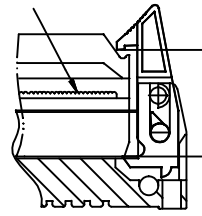

No. of PINS	Dimension Information		
	A	B	C
06	5.08	26.82	16.62
08	7.62	29.36	19.16
10	10.16	31.90	21.70
14	15.24	36.98	26.78
16	17.78	39.52	29.32
18	20.32	42.06	31.86
20	22.86	44.60	34.40
24	27.94	49.68	39.48
26	30.48	52.22	42.02
30	35.56	57.30	47.10
34	40.64	62.38	52.18
40	48.26	70.00	59.80
50	60.96	82.70	72.50
60	73.66	95.40	85.20
64	78.74	100.48	90.28

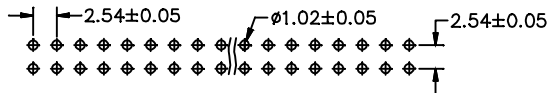

针:0.64x16

Ordering Information

E1XX-1 XX XX X S XXX X X

NO.OF PINS PER ROW
6-64P

INSULATOR MATERIAL:
A :PBT
B :PA6T
C :PA9T
D :LCP

LENGTH OF TERMINAL

PACKING
A:PE Bag
B:Tape & Reel
C:Tube
D:Tube+CAP
E:Tray

Contact Plating
Full Of Gold Semi-gold
A0=0.8u B0=0.8U"
A1=1u B1=1U"
A2=1.5u B2=1.5U"
A3=2u B3=2U"
A4=3u B4=3U"

operatop

XX	±0.25
XX	±0.20
XXX	±0.10
Angle	±3°
DIM	TOL

SCALE

UNIT

SIZE

SHEET

PROJ.

Fit

MM

DFSIGH

CHECK

APPROLE

Mxcon

深圳市镁旺电子科技有限公司
Shenzhen Meiwang Electronic Technology Co., Ltd.

江泽富

PART NO.

TITLE:

Customer No.

E1XX-1XXXXXXSXXXX

2.54MM牛角 180度

REV	DATE	MODIFICATION DESCRIPTION	CHANGE	APPROVE

1

2

3

4

5

6

7

8

9

10